

# Canon



*ivy*  
**CLIQ 2**

**Instant Camera Printer**  
User Manual

# CONTENT

## **SAFETY INFORMATION** P3-4

Read Before Use

## **OVERVIEW** P5

Supplied Items

Product Features

## **SETUP** P6-9

Charging

Loading Paper

External Memory

## **OPERATION** P10-12

Power ON/OFF

Taking and Printing a Photo

Viewfinder

Selfie Mirror

Built-in Filter and Border Buttons

## **LED INDICATOR** P12-13

Troubleshooting

## **SPECIFICATIONS** P14

# SAFETY INFORMATION

## READ BEFORE USE

Please read the following instructions and safety precautions before using the device.

For regulatory and additional safety information, refer to the Regulation and Warranty Information sheet included in your package contents.

### RMN: PP3002

Regulatory Model Identification Number is assigned for regulatory identification purpose.



## WARNING

Used to indicate a potentially hazardous situation which, if not avoided, could result in death or serious injury.

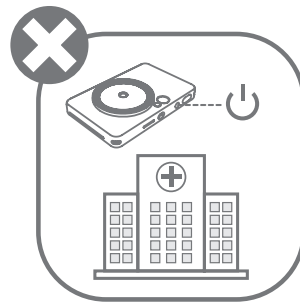
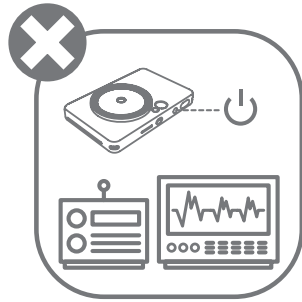
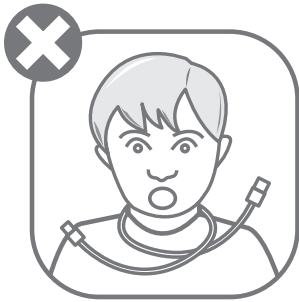
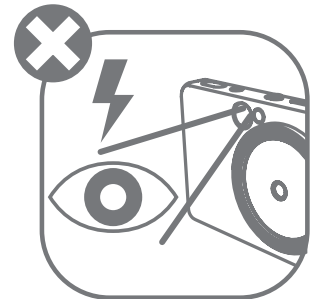
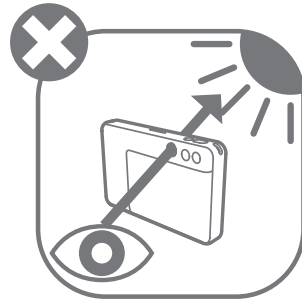
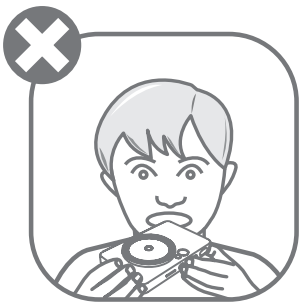

- Keep away from children and infants. Improper use of this product may cause suffocation or accident.
- Stop using the device immediately if it emits smoke or a strange smell, or otherwise behaves abnormally.
- Do not look at the sun or bright lights through the viewfinder or the lens. Blindness or vision problems could result.
- Do not fire the flash near the eyes. It may hurt the eyes.
- A strap wound around a child's neck may result in asphyxiation. If your product uses a power cord, mistakenly winding the cord around a child's neck may result in asphyxiation.
- Turn the device off in places where camera use is prohibited. The electromagnetic waves emitted by the camera may interfere with the operation of electronic instruments and other devices. Exercise adequate caution when using the product in places where use of electronic devices is restricted, such as inside airplanes and medical facilities.



## CAUTION

Used to indicate the level of a hazard or damage which, if product is handled erroneously, may result in injury or property damage other than product faults.

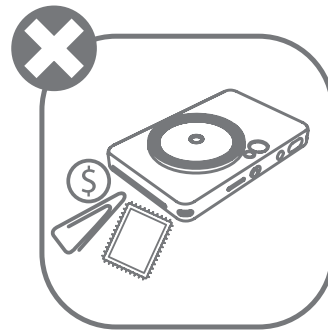
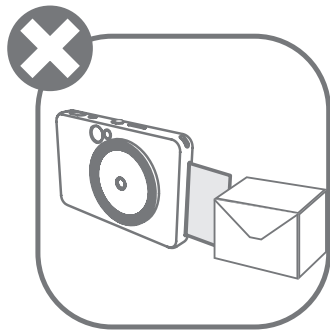
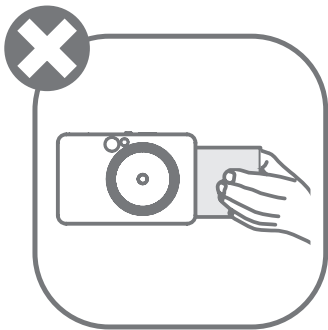
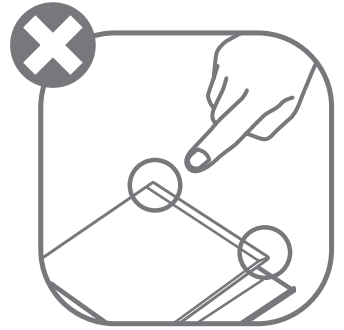
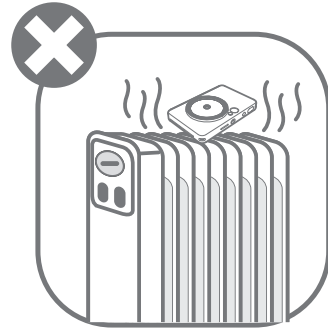

- When operating in extreme weather, the device might not print. Let the printer temperature adjust to the recommended operating temperature of 59° to 90°F (15° to 32°C), before attempting to print again.
- When charging, please charge the device at the recommended temperature of 59° to 90°F (15° to 32°C).
- Use a soft dry cloth to clean the device. Do not clean with a damp cloth or volatile liquids such as paint thinner.
- Keep the top cover closed to avoid dust and other particles from entering the inside of the device.
- If the device is not functioning properly, please contact the dealer you purchased this product from or Canon Service & Support at [www.usa.canon.com/support](http://www.usa.canon.com/support)
- Never expose the battery to high temperatures, direct heat, or dispose by incineration.
- Electromagnetic interference or electrostatic discharge may cause the device to malfunction or the memory to be lost or altered. Should this occur, use a pin, or similar item to press the [RESET] button at the bottom of the device.

# OVERVIEW

## SUPPLIED ITEMS

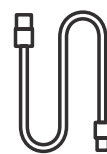
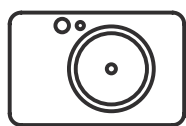

Instant Camera Printer

Quick Start Guide

Regulation and  
Warranty  
Information sheet

CANON ZINK®  
Photo Paper  
(10 sheet)

USB Cable

Wrist Strap

## PRODUCT FEATURES

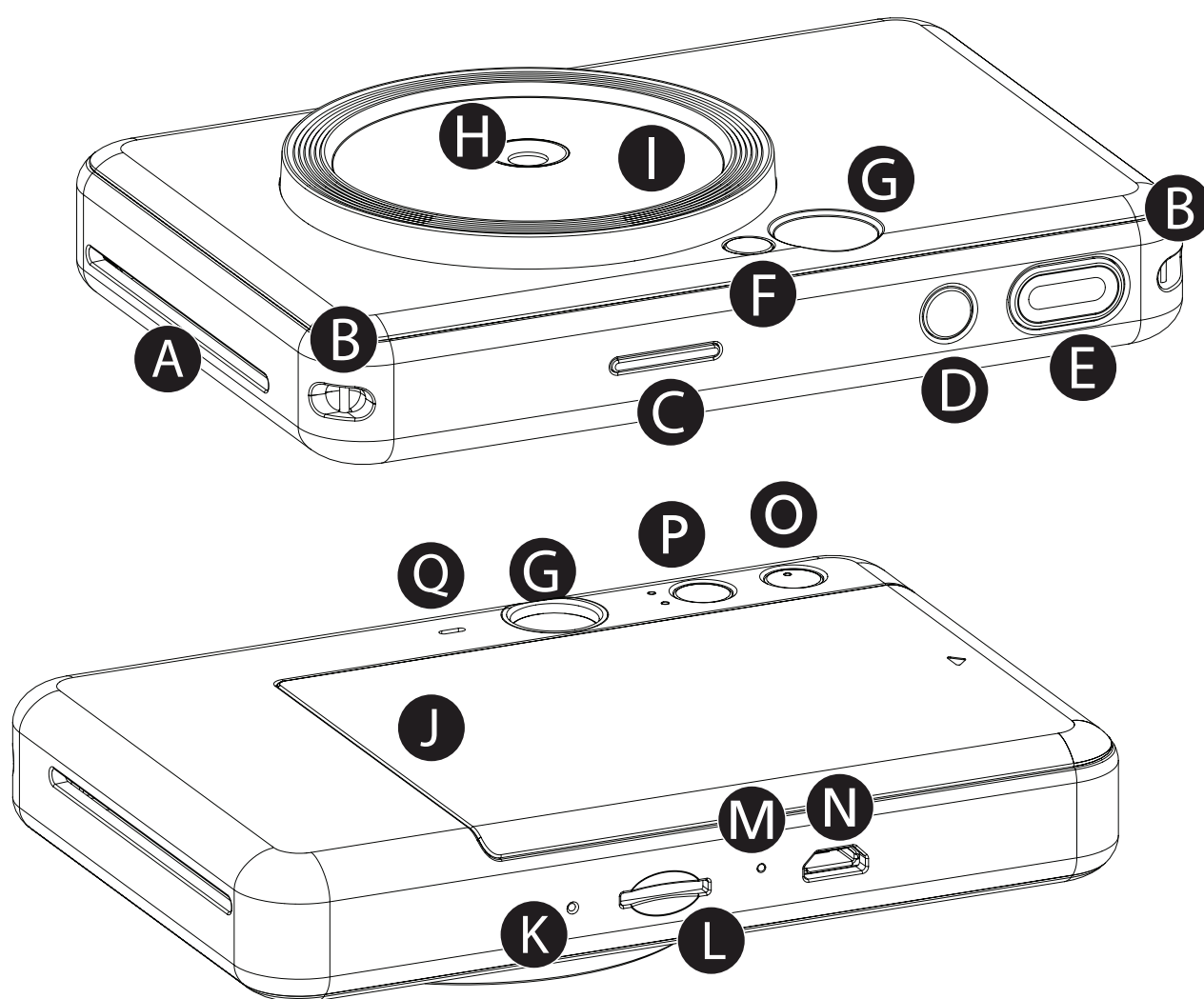

**A** Print Out Slot

**B** Wristband Eyelet

**C** Status LED

**D** Power Button

**E** Shutter Button

**F** Flash

**G** Viewfinder

**H** Camera Lens

**I** Selfie Mirror

**J** Printer Cover

**K** Reset Button

**L** MicroSD Card Slot (up to 256GB)

**M** Charging Status LED

**N** Micro USB Port

**O** White Border Button

**P** Filter Button

**Q** Speaker

# SETUP

## CHARGING

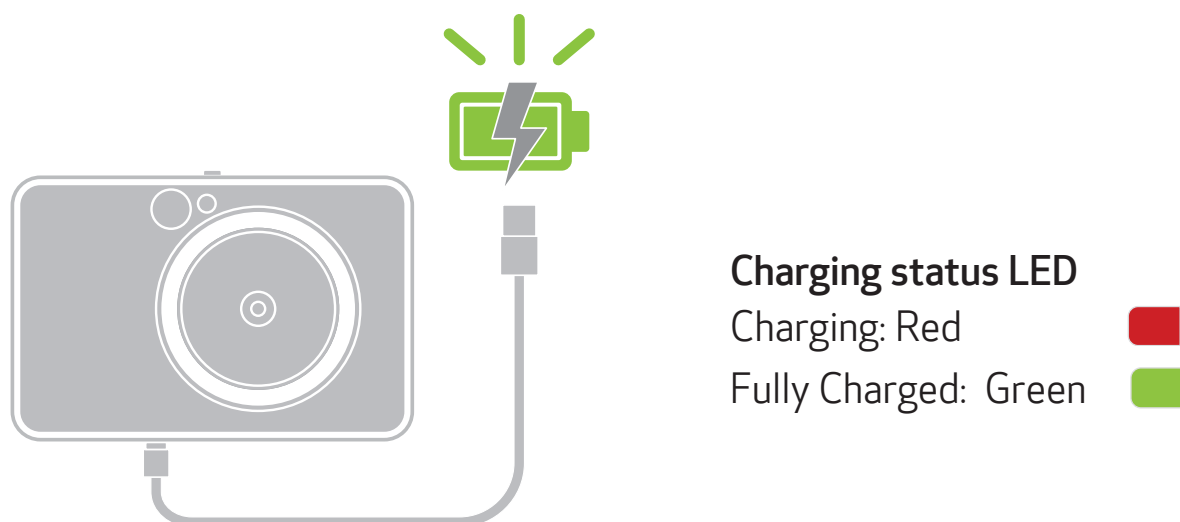

The device has a built-in battery. Please fully charge the device via the USB cable provided before using.

- 1 Insert the smaller end of the supplied USB cable into the device and other end into a chargeable USB adapter.
- 2 The charging LED light will turn red to indicate charging.
- 3 Once fully charged, the charging LED will turn green.
  - Operating time may vary depending on the battery status, operational status and environment conditions.

**\* Make sure to fully-charge your IVY CLIQ product(s) at least once every three (3) months. If the product is not charged/used for an extended period of time, you may not be able to charge the built-in battery and the product may no longer power on.**

## ! NOTE

### ABOUT USB CABLE

#### HANDLE THE USB CABLE WITH CARE WHILE CHARGING

- Do not place any heavy objects on top of the cable.
- Do not place the USB cable near heat.
- Do not scratch, damage, twist or pull hard on the cable.
- Do not plug or unplug the cable with wet hands.
- Avoid too high/too low temperature or humid conditions.
- Please unplug the USB cable from power source after charging.
- Please use the supplied USB cable for charging.

## LOAD PAPER

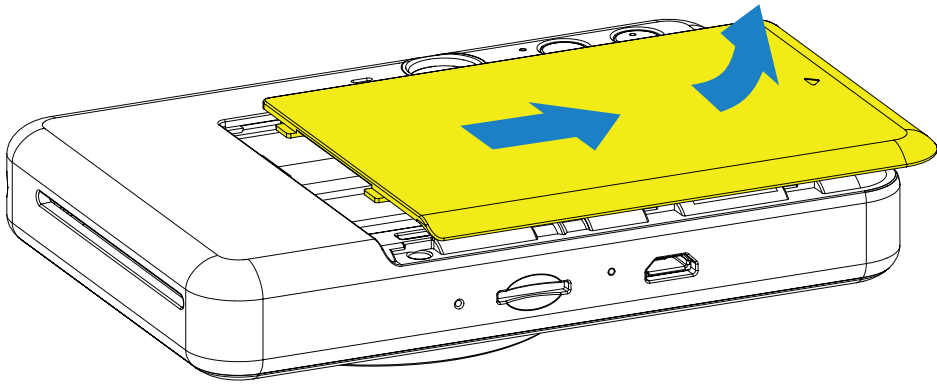

- 1 Remove the cover by sliding it forward in the direction of the arrow.

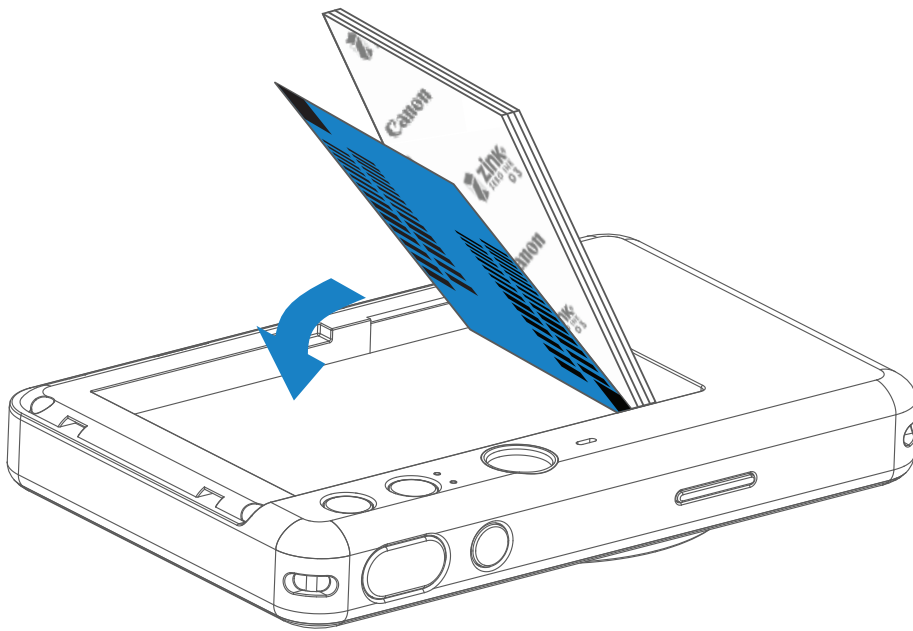

- 2 Open a single pouch of photo paper (10 sheets + blue SMART SHEET®).
- 3 Place all 10 photo paper sheet and the one blue SMART SHEET® into the photo paper compartment.
  - Stack the photo paper on top of the blue SMART SHEET®, making sure the barcode and the photo paper logos are facing down.

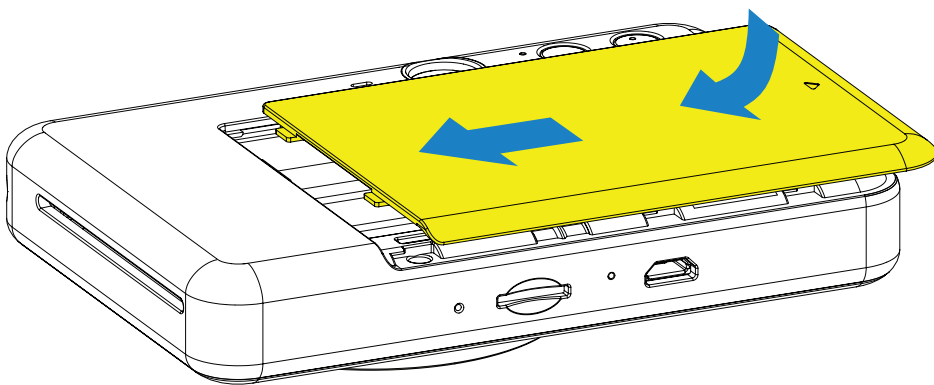

- 4 Place the top cover back onto the device. It should click into place when closed properly.
  - The blue SMART SHEET® will be sent through the device automatically before the first print.

## EXTERNAL MEMORY

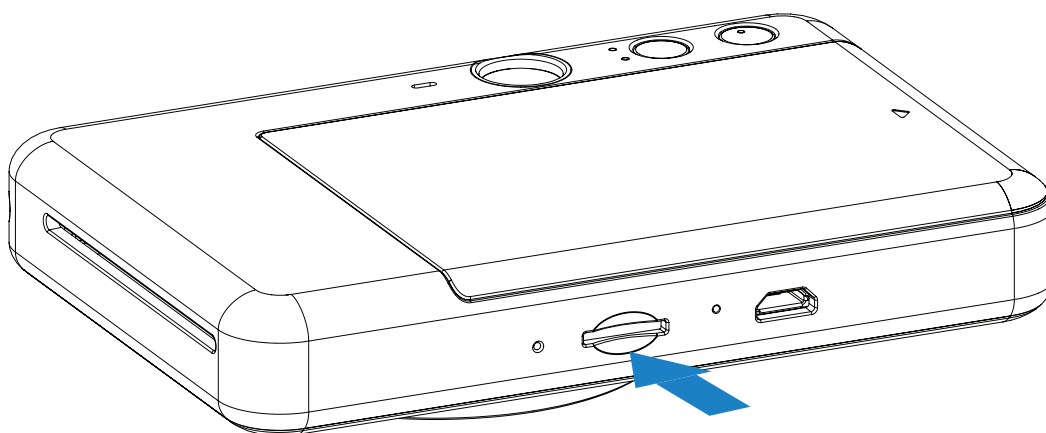

 An external MicroSD card (up to 256 GB) is needed for saving captured photos and videos.

### PREPARING A MEMORY CARD

Use the following memory cards (sold separately)

- MicroSD memory cards \*1
- MicroSDHC memory cards \*1 \*2
- MicroSDXC memory cards \*1 \*2

\*1 Cards conforming to SD standards. However, not all memory cards have been verified to work with the camera.

\*2 UHS-I memory cards are also supported.

### INSERT AND REMOVE THE MicroSD CARD

- Insert the MicroSD card into the slot at the bottom of the device. You will feel a slight click when the card is fully inserted .
- Push on the top of the card to release it. Gently pull to fully remove the card from the device.
- If there is an error reading /writing to the MicroSD card, the MicroSD Error LED indication will be displayed. Remove the MicroSD card and restart the device.
- Connect the device to a computer with the USB cable provided. Double-click the external drive image when it appears on the computer to view and save the photos.



## NOTE

### MAINTAINING THE DEVICE

- Use and keep the device in the recommended environment of 59° to 90° F (15° to 32° C) and 40-55% relative humidity.

### WHEN USING PHOTO PAPER



- Only load 10 photo paper sheets and 1 blue SMART SHEET<sup>®</sup>. Do not load more as it can result in paper jams or printing errors.
- If there is a paper jam, simply turn the printer OFF and ON to automatically clear the paper jam. Don't try to pull the paper out.
- While the device is printing, don't pull or tug on the paper, this could result in a paper jam or print error.
- Don't open a new pouch of photo paper until you are ready to load it into your device.
- Don't expose photo paper to direct sunlight or moisture.
- Don't leave your photo paper in an area where the temperature or humidity is out of the suggested conditions indicated on the pouch. It may reduce the quality of the printed photo.

### ABOUT THE BLUE SMART SHEET<sup>®</sup>

- Each pouch of photo paper contains 10 sheets of photo paper and 1 blue SMART SHEET<sup>®</sup>.
- Load the blue SMART SHEET<sup>®</sup> and photo paper from within the same pouch for optimal print quality. Each blue SMART SHEET<sup>®</sup> is specifically tuned for the pouch of paper it is contained in.
- The blue SMART SHEET<sup>®</sup> will be sent through the device automatically before the first print to clean the printer and optimize print quality for that specific paper pouch (10 sheets).
- Keep the blue SMART SHEET<sup>®</sup> and only discard after you have printed all 10 sheets of photo paper in the pouch. If print quality is not as expected, you can reuse the blue SMART SHEET<sup>®</sup> if the paper is still from the same pouch. Simply slide the blue SMART SHEET<sup>®</sup> with its barcode-side down underneath the remaining photo paper.
- Using a blue SMART SHEET<sup>®</sup> from a different pouch may result in reduced print quality.

# OPERATIONS

## POWER ON/OFF

- 1 Press and hold the Power button  until the LED indicator light turns on.
- 2 When the LED indicator turns to a steady white, the device is ready to Use.
- 3 Press and hold the Power button  to turn off the device.

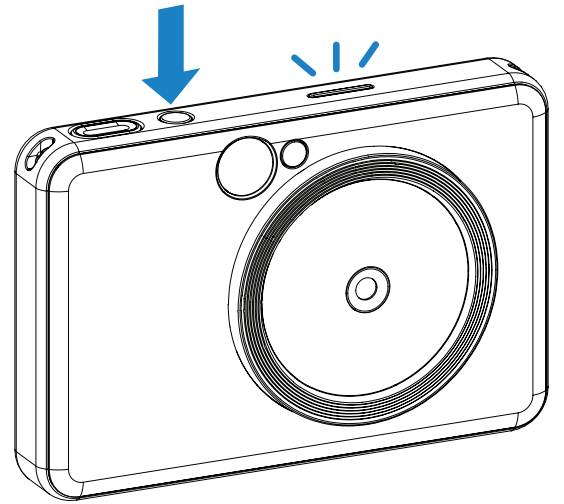

### AUTO POWER OFF

- When the device is idle for about 5 minutes, it will automatically power off. User can resume the device by pressing the Power button again.

## TAKING AND PRINTING A PHOTO

- 1 Hold the device, confirm the desired composition of the image.
- 2 Press the Shutter button  to take a photo. The camera will automatically trigger the flash if it is necessary for the lighting conditions.
- 3 The photo will be printed out immediately after taking the photo, if paper is inserted. The device can hold up to around 10 images at a time to print, it depends on SD card\* capacity.

\* Print queue will be cleared once the device is powered off and cannot be resumed.

\* If no SD card is inserted, the device can hold up to 3 images at a time to print.

- 4 User can take photos with the device even with no paper if SD card is inserted, photos will be saved in SD card.

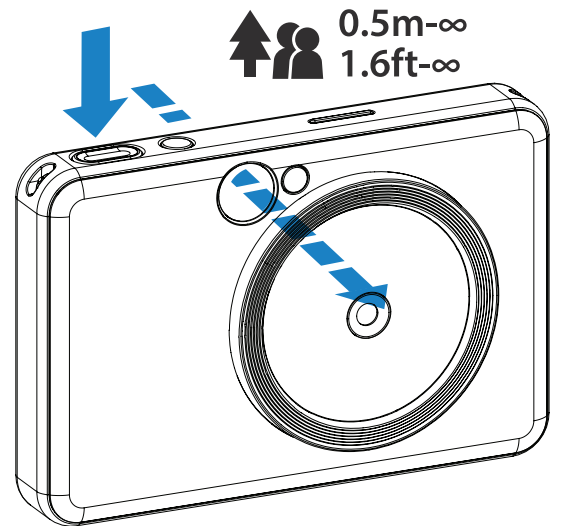

## VIEWFINDER

Compose an image with the frame mark in the viewfinder.



2 x 3



2 X 3 Frame Mark  
for normal shooting  
at 3.3ft - ∞

# SELFIE MIRROR

Compose an image with the frame mark in the Selfie Mirror.



Focusing distance at 1.6ft

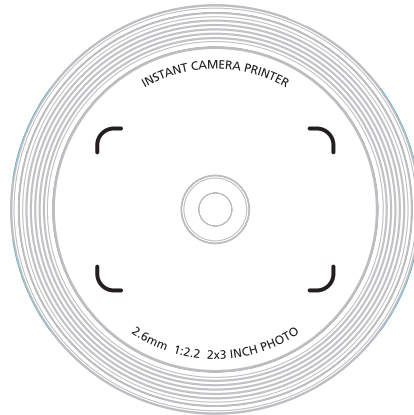

## BUILT-IN FILTER AND BORDER BUTTONS

### FILTER

- User can add either black and white or vivid filter to a photo by pressing  button before taking photo.



Easily add a filter or border to your photos right on the camera.



No Filter without Border



Black & White Filter without Border



Vivid Filter without Border

### BORDER

- User can also chose to add white border to a photo by pressing  border button before taking photo.



No Filter with Border

















Black & White Filter with Border





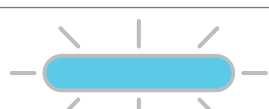

Vivid Filter with Border

- Both original photo and photo with effect added will be saved in SD card, while only the photo with effect added will be printed out.

# LED INDICATOR

Status	Mode LED	Status LED
Power On	Press and hold Power button	 >  White White
Standby	After the device is powered on	 White
Power Off	Press and hold Power button	 Off
Blue SMART SHEET® Error	When the device detects wrong blue SMART SHEET® is inserted, or other blue SMART SHEET® error	 Blue
Processing Blue SMART SHEET®	When the device is loading blue SMART SHEET®	 White
Paper Jam/ Cover Open	When there is a paper jam or the printer cover is opened	 Red
No paper and No SD card inserted	When the device has no paper and no SD card inserted, the device will not allow to taking photo.	 Red
Get Ready for Printing	Preparing for printing	 White
Printing Photo	When the device is printing a photo	 Yellow >Magenta>Cyan>White (Looping)
MS Mode (MassStorageMode)	Device is connected to a computer	 Magenta
Temperature Too High	When device temperature is too high	 Red (Until temperature returns to normal)
Temperature Too Low	When device temperature is too low	 Cyan (Until temperature returns to normal)
Printer Head Cooling	Checking the printer head temperature and letting it cool down before printing	 Cyan
Low Battery	When battery level down to 20%	 White>Red (Looping)
Firmware Upgrading	When the device is updating firmware	 White

## TROUBLESHOOTING

Status	LED Indication	Actions
<b>MicroSD Card Error</b>	 <p>Magenta</p>	<ul style="list-style-type: none"> <li>• Check if the MicroSD card is inserted properly</li> <li>• Check if the MicroSD card is full</li> <li>• Check if the MicroSD card is corrupted</li> <li>• Check if the MicroSD card is compatible</li> </ul>
<b>Paper Feeding Failed</b>	 <p>Red</p>	<ul style="list-style-type: none"> <li>• Open the paper compartment cover to check if Canon ZINK™ photo paper is inserted</li> </ul>
<b>Paper Jam</b>	 <p>Red</p>	<ul style="list-style-type: none"> <li>• Power off and on the device, the photo paper will be fed out automatically</li> </ul>
<b>Printer Cover is not closed properly</b>	 <p>Red</p>	<ul style="list-style-type: none"> <li>• Close the printer cover properly. Make sure smartphone OS is compatible and up to date</li> </ul>
<b>Device does not Work</b>	N/A	<ul style="list-style-type: none"> <li>• Make sure the battery level is not too low. If it is, recharge the device</li> </ul>

# SPECIFICATIONS

Printing Technology	ZINK®
Printing Resolution	314 x 600 dpi (dots per inch)
Printing Speed	Approximately 50 seconds - Motor starts and stops, at room temperature 77 °F (25 °C)
Photo Aspect Ratio	2" x 3"
Compatible Paper	Canon ZINK® Photo Paper : ZP-2030-20 (20 sheets) ZP-2030-50 (50 sheets) / 2" x 3" / Peel-and-Stick Back
Paper Capacity	Up to 10 sheets of ZINK® photo paper + 1 blue SMART SHEET®
Photo Resolution	5MP
Focal Length	2.6mm
Aperture	f 2.2
Focusing Range	1.6ft (50cm) - ∞
Sensitivity	Auto (ISO 100 - 1200)
Flash	YES (Auto)
Flash Range	1.6ft. (0.5m) - 3.2ft. (1m)
Memory Card	MicroSD Card, up to 256GB
Photo Format	JPEG
Power Source	Built-in Rechargeable Li-Polymer Battery 700mAh, 7.4V <sup>---</sup>
Charging Speed	Approximately 110 minutes (Full Charge)
Power Adapter	Output Current : 1A (min) Voltage : 5V <sup>---</sup>
Environment Parameters	<ul style="list-style-type: none"> <li>- Recommended Printing Operating, Charging, and Storage Temperature : 59° to 90° F (15° to 32° C)</li> <li>- Recommended Printing Operating, Charging, and Storage Humidity : 40-55% RH</li> <li>- Operating Temperature : 41° to 104° F (5° to 40° C)</li> <li>- Operating Humidity : &lt; 70% RH</li> </ul>
Automatically Power-Off	5 minutes
Dimension	4.8" (W) x 3.2" (H) x 0.9" (D) / 121mm (W) x 81.5mm (H) x 24mm (D)
Weight	6.6 oz / 188 g
Compatible OS (for computer)	Windows 7 / 8 / 8.1 / 10 Mac OSX 10.10-10.15
Connection for Charging and Data Transfer	USB 2.0 (Micro USB)

All specifications are subject to change without notice



If the device is not functioning properly, please contact the dealer you purchased this product from or Canon Service & Support at [www.usa.canon.com/support](http://www.usa.canon.com/support)

#### **FCC REGULATIONS**

This device complies with Part 15 of the FCC Rules. Operation is subject to the following two conditions: (1) this device may not cause harmful interference, and (2) this device must accept any interference received, including interference that may cause undesired operation.

Canon U.S.A., Inc. Canon is a registered trademark of Canon Inc. in the United States and may be a registered trademark, or trademark, in other countries. IVY is a trademark of Canon U.S.A., Inc. in the United States. SMART SHEET, the ZINK Technology and ZINK Trademarks are owned by ZINK Holdings LLC. Used under license.